

FBHA Series



FEATURES

- Noise reduction solution for power line.
- Compared to the FBA series, has low direct current resistance for compatibility with large currents, optimal for low power consumption.
- Various frequency characteristics with 2 materials of different features for countermeasures against everything from general signals to high-speed signals.
- Performs well even in signal lines where low direct current resistance is required.
- AEC-Q200 qualified.
- Operating temperature: -55 to +150 °C (including self-temperature rise)
- Quantity: 4000PCS

APPLICATION

- Power line filter for body controls, and car multimedia etc.

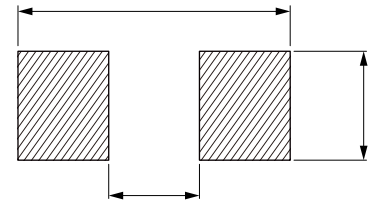
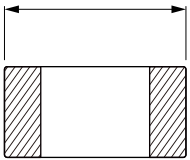

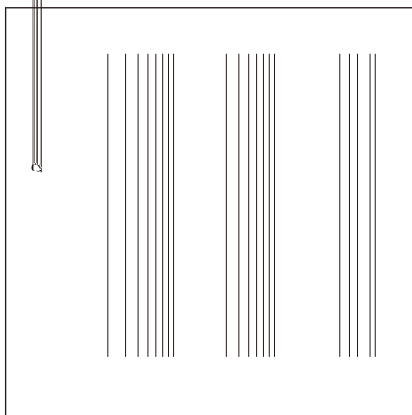
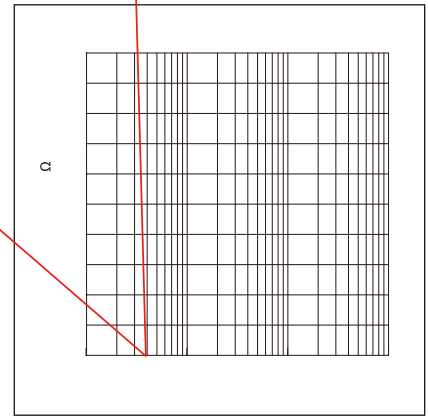
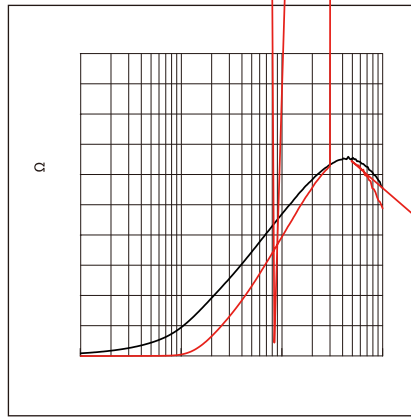
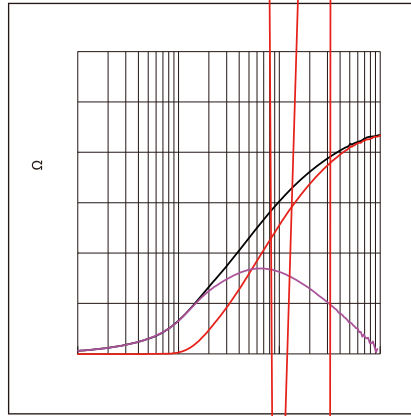
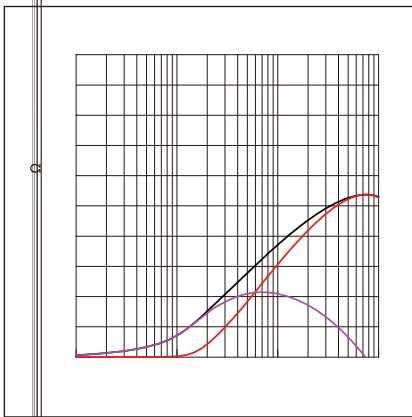

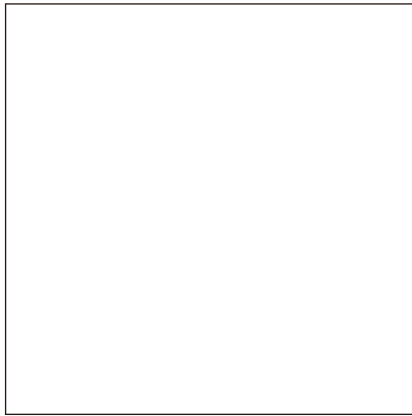
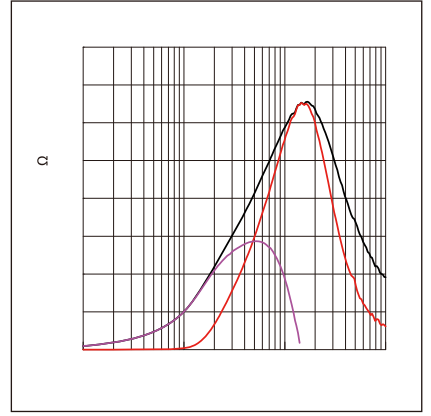
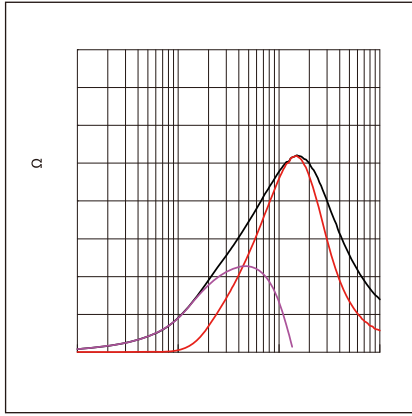

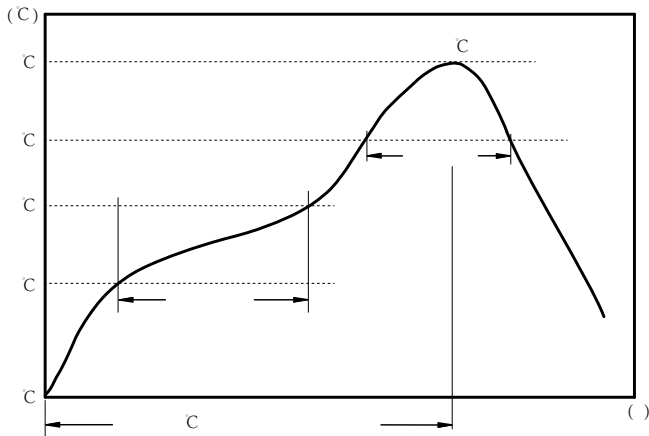

c
c
c

:

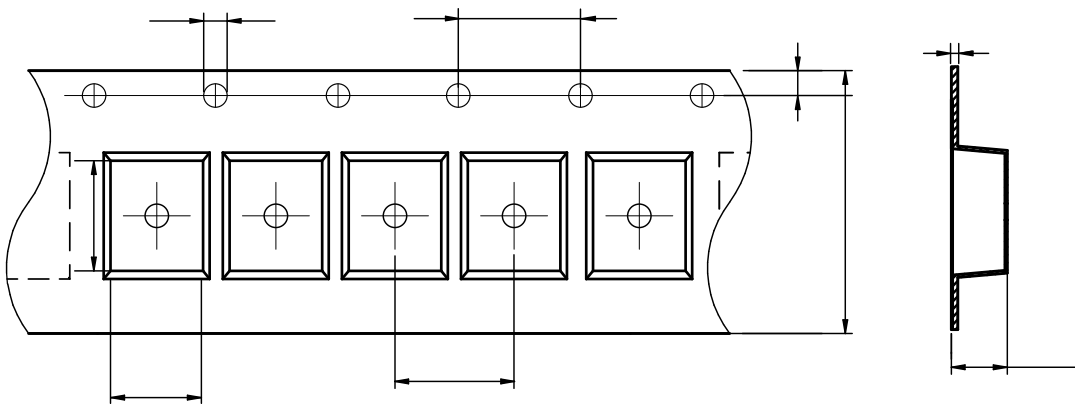

FBHA0805	1.30±0.05	2.10±0.05	1.5±0.1	4.0±0.1	4.0±0.1	8.0±0.3	0.95±0.05	1.75±0.1	0.95±0.05

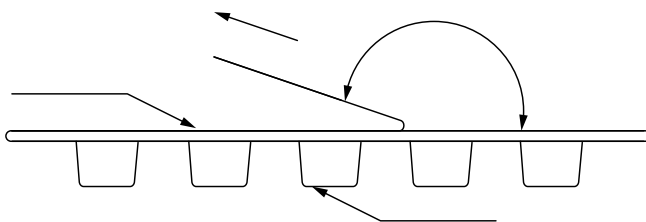

The peel force of top cover tape shall be between 0.14 to 0.58 N

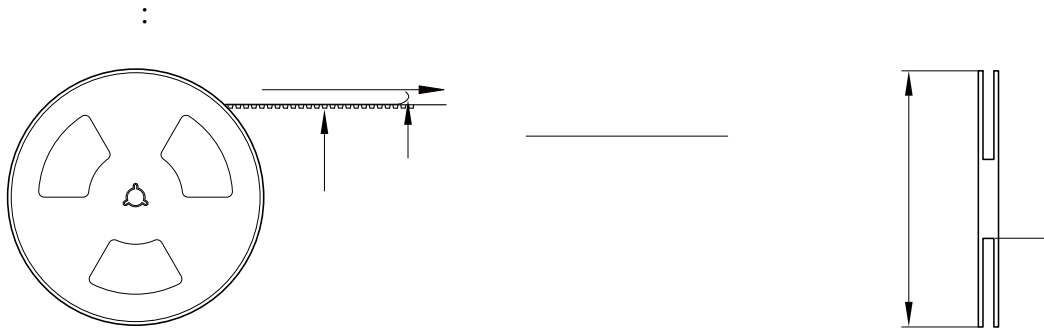

:

-
-
-
-
-
-
-
-