

# MDA HT Series

## FEATURES

High performance realized by metal dust core and hot pressing process.



## APPLICATION

Thermal management products, such as water pumps and valves

HVAC

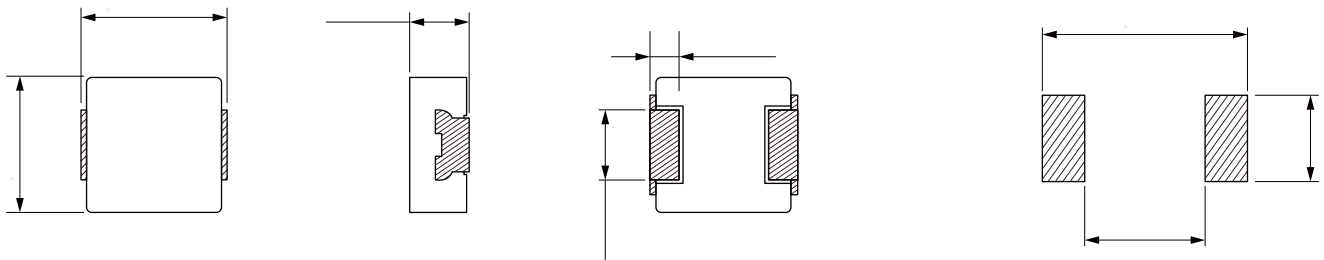

Part No	Inductance @ 100KHz/1V	Tolerance	Temperature Rise Current Typ.	Temperature Rise Current Max.	Current Typ.	Current Max.	DC Resistance Max.
MDA1365HT-R68M	0.68	±20%	38.0	30.0	29.0	20.0	1.7
MDA1365HT-1R0M	1.00	±20%	32.0	27.5	20.0	17.0	2.1
MDA1365HT-1R5M	1.50	±20%	26.0	23.0	18.0	15.4	3.0
MDA1365HT-2R2M	2.20	±20%	21.0	18.9	17.5	15.0	4.5
MDA1365HT-3R3M	3.30	±20%	18.3	16.5	17.0	14.6	6.0
MDA1365HT-4R7M	4.70	±20%	15.0	13.5	13.5	11.6	8.7
MDA1365HT-6R8M	6.80	±20%	13.8	12.8	10.5	9.0	11.3
MDA1365HT-100M	10.0	±20%	11.0	9.9	9.2	7.9	17.2
MDA1365HT-150M	15.0	±20%	8.7	7.8	7.2	6.2	28.2
MDA1365HT-220M	22.0	±20%	7.0	6.2	6.3	5.4	40.0
MDA1365HT-330M	33.0	±20%	5.5	5.0	4.3	3.7	69.0
MDA1365HT-470M	47.0	±20%	4.2	3.8	3.8	3.3	104

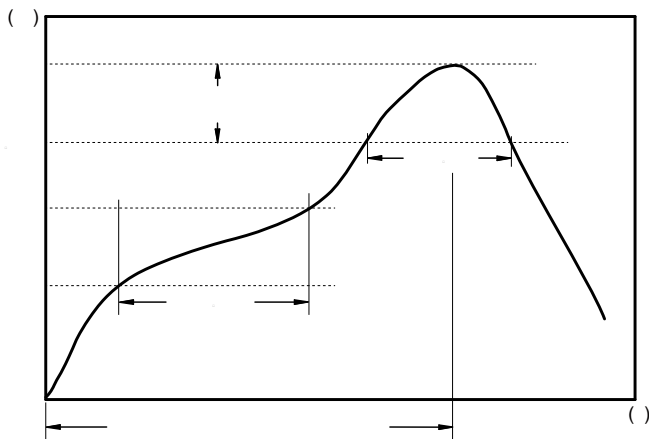

:

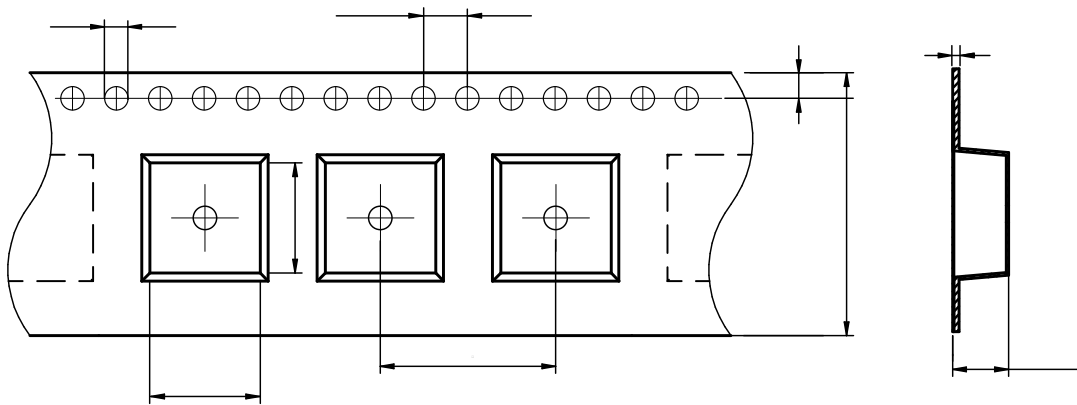

MDA1365HT	13.1±0.1	14.0±0.1	1.5±0.1	4.0±0.1	16±0.1	24±0.3	6.7±0.1	1.75±0.1	0.50±0.05

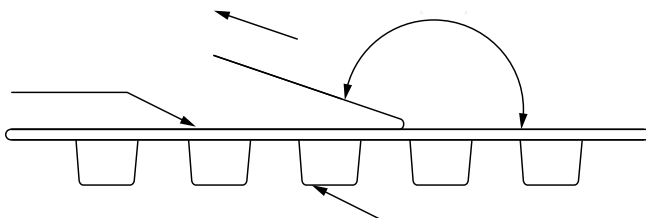

The peel force of top cover tape shall be between 0.1 to 1.3 N

Marking	KH+Printing (Inductance+period)
---------	---------------------------------

:

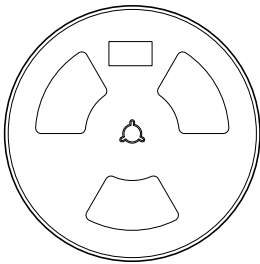
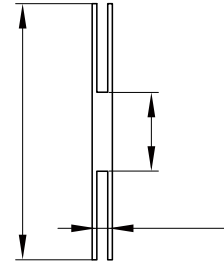
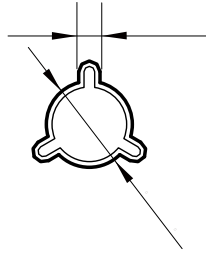
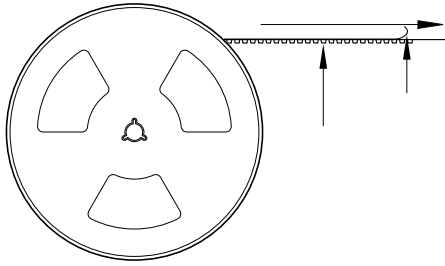

500 Pcs/Reel

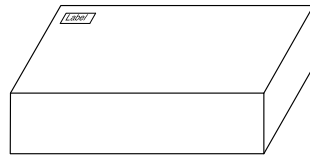

2 Reel /Inner box( 1000 Pcs)

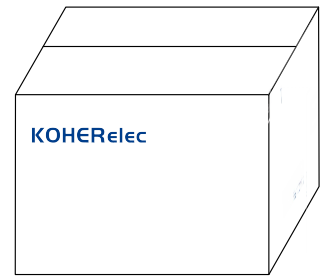

2 Inner box/Carton box(2K Pcs)

:

- 
- 
- 
- 
- 
- 
- 
- 
-