

SCM Series

FEATURES

-
-
-
-

APPLICATION

-

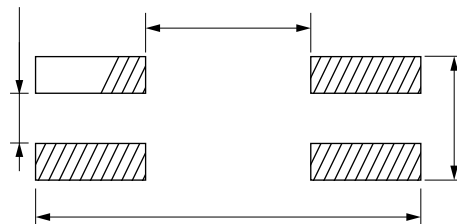
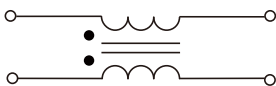
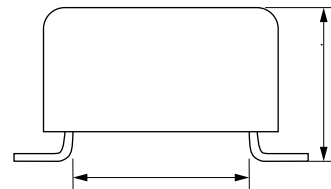
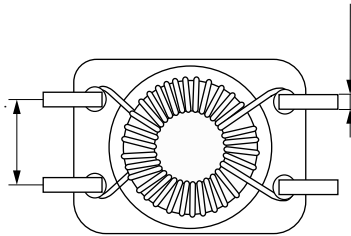
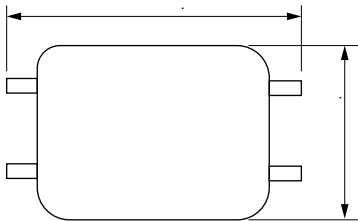
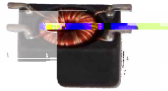

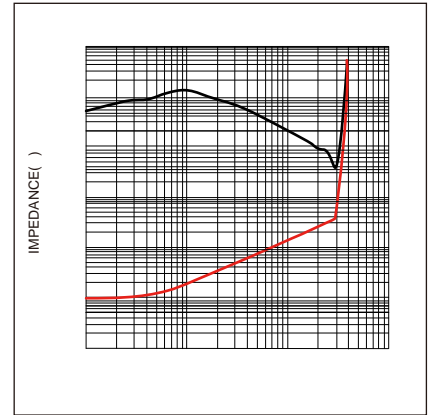
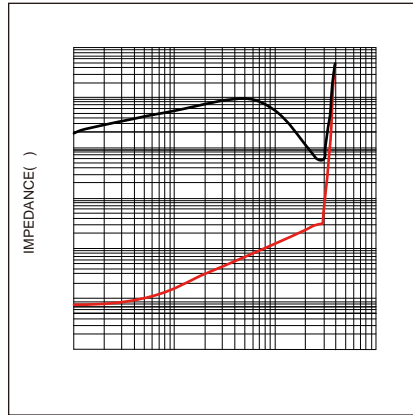
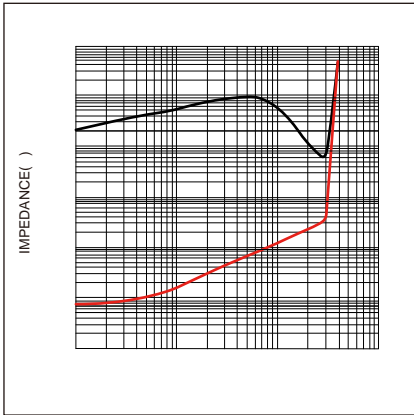

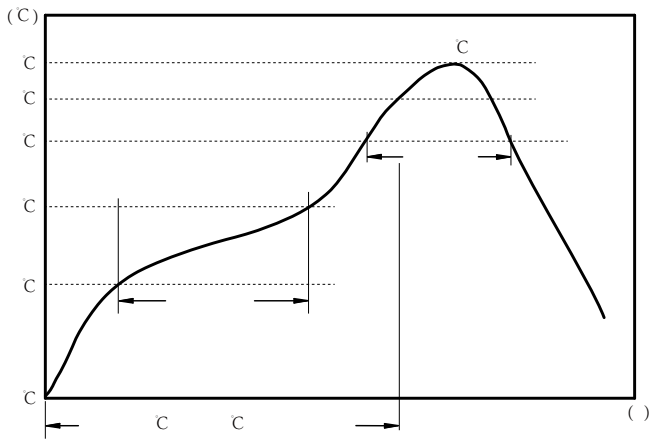

C
C
C

:

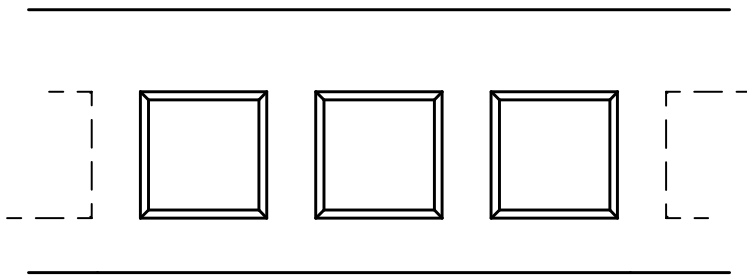

SCM9040	5.85 ± 0.1	9.60 ± 0.1	1.5 ± 0.1	4.0 ± 0.1	8.0 ± 0.1	16.0 ± 0.3	4.92 ± 0.1	1.75 ± 0.1	0.50 ± 0.05
---------	----------------	----------------	---------------	---------------	---------------	----------------	----------------	----------------	-----------------

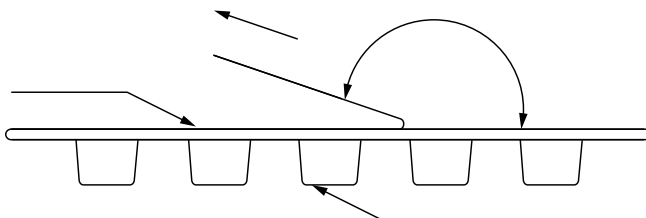

The peel force of top cover tape shall be between 0.1 to 1.17 N

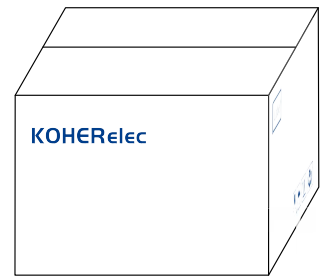
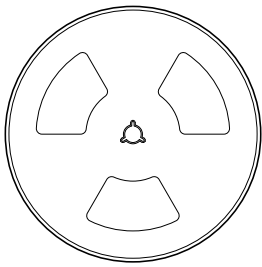
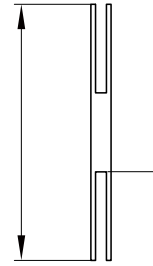
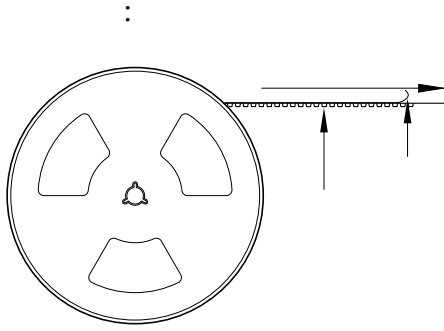

1500 Pcs/Reel

2 Reel /Inner box(3000 Pcs)

3 Inner box/Carton box(9K Pcs)

:

•

•

•

•

•

•

•

•